

### Items Supplied >

- 1 – FRONT HEADPIPE AND HEATSHIELD
- 1 – REAR HEADPIPE COLLECTOR ASSEMBLY AND HEATSHIELD
- 1 – LEFT REAR CROSSOVER PIPE AND HEATSHIELD
- 1 – BRACKET, FRONT HEADPIPE SUPPORT
- 1 – BRACKET, CROSSOVER WITH GROMMET PIPE SUPPORT
- 1 – FLOORBOARD MOUNT SPACER PLATE
- 1 – CLAMP, FRONT HEADPIPE SUPPORT
- 9 – CLAMP, HOSE HS-24
- 1 – CLAMP, HOSE HS-36
- 1 – THICK 3/8" WASHER
- 1 – THIN 3/8" WASHER
- 1 – 3/8" X 1" CARRIAGE BOLT
- 1 – 3/8" NYLOCK NUT
- 2 – 1/4 SHOULDER BOLTS
- 2 – 1/4 LARGE FLAT WASHERS
- 2 – 5/16 LARGE FLAT WASHERS
- 2 – CLAMP, 27-61 MSC

### Application(s) >

HARLEY:  
DRESSER '17-'24

### Instruction Manual >

6255RB

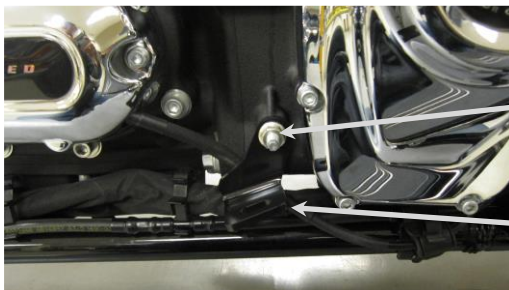
Page 1 of 6

**ATTENTION! THESE HEADPIPES WILL NOT WORK IN COMBINATION WITH STOCK HARLEY DAVIDSON MUFFLERS DUE TO RIGHT MUFFLER SLIP DESIGN.**

**PRIOR TO INSTALLATION, MAKE SURE YOUR STOCK HEADPIPE GASKETS ARE IN GOOD CONDITION. IF YOU HAVE ANY DOUBTS AS TO THEIR CONDITION, REPLACE THEM.**

**Read all instructions carefully and completely before installing your new exhaust system!**

1. Remove the saddle bags, right side cover, and right front floorboard from the frame.
2. Unplug the O<sub>2</sub> sensors on the front and rear headpipes from the motorcycle wire harness.
3. Remove the stock exhaust system being careful not to damage the headpipe gaskets. If the headpipe gaskets are in good condition they do not need to be removed from the cylinders. Remove and save the flanges, nuts, retaining rings, muffler clamps, muffler mount bolts, crossover bracket bolts, and O<sub>2</sub> sensors from the stock exhaust. Label the O<sub>2</sub> sensors front and rear to ensure they will be installed on the proper headpipe.
4. Remove the stock exhaust mount bracket.
5. Install the supplied headpipe support bracket using the stock nut. On 2017-2020 models route the hydraulic clutch line behind the bracket. On 2021+ models route the clutch cable in front of the bracket. See **FIGURES 1 & 2**. Lightly snug the nut but **DO NOT TIGHTEN** so the bracket can be adjusted. The bracket should be positioned at a slight angle.



**FIGURE 1**  
2017 – 2020  
MODELS

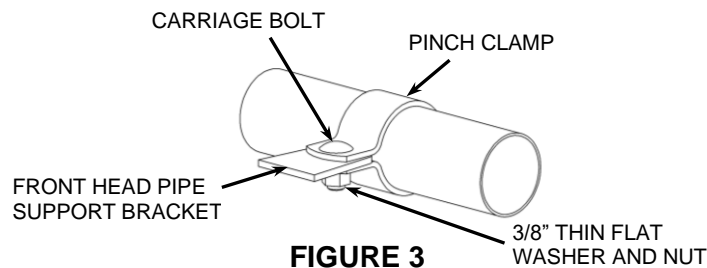


**FIGURE 2**  
2021+  
MODELS

**Continued on Page 2**

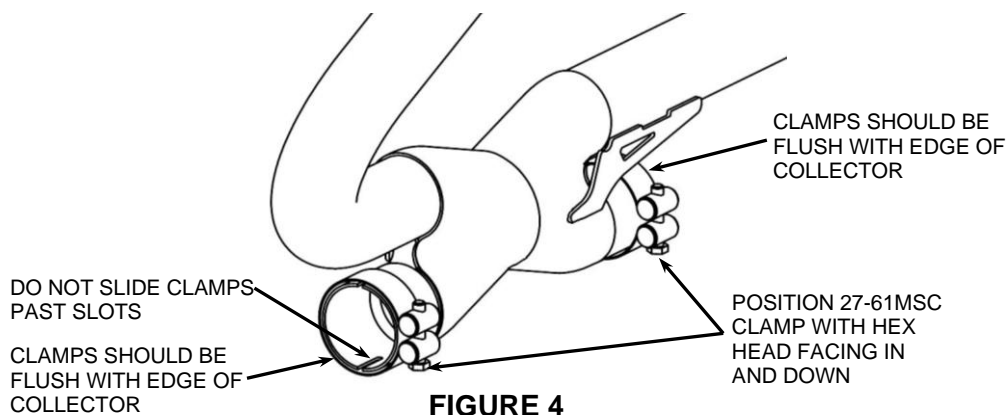
**DISCLAIMER: NOT LEGAL FOR SALE OR USE IN CALIFORNIA ON ANY POLLUTION CONTROLLED MOTOR VEHICLE. THE SALE, USE, OR INSTALLATION OF THIS PRODUCT MAY ALSO BE ILLEGAL NATIONWIDE UNDER THE FEDERAL CLEAN AIR ACT (42 U.S.C. § 7522(A)(3)).**

6. Install the stock flanges, retaining rings and O<sub>2</sub> sensors onto the supplied front and rear headpipes. Be sure to install the front O<sub>2</sub> sensor on the front headpipe and the rear O<sub>2</sub> sensor on the rear headpipe.
7. Install the front headpipe (with stock gasket in place) onto the front cylinder using the stock nuts. Snug the nuts but **DO NOT TIGHTEN** at this time.
8. Slide the supplied pinch clamp over the front headpipe making sure the square hole on the clamp is facing up and towards the inside. Position the clamp over the support bracket so that the pinch clamp captures both sides of the bracket. See **FIGURE 3**. Insert the supplied 3/8" carriage bolt through the top of the pinch clamp and support bracket. Install the 3/8" thin flat washer and nut onto the bottom of the carriage bolt but **DO NOT TIGHTEN** at this time. Leave the nut loose so the headpipe can be adjusted.



**FIGURE 3**

9. Position (2) of the supplied #27-61 MSC muffler clamps onto the rear headpipe collector assembly inlet and outlet. The hex head of both clamps should be inward and down. See **FIGURE 4**. (NOTE: The clamps should be flush with the end of the inlet and outlet when tightened. See **FIGURE 4**. If the clamps are slid past the slots on the inlet and outlet the clamps will not tighten properly).



**FIGURE 4**

(INWARD SIDE OF COLLECTOR)

10. Install the rear headpipe collector assembly (with stock gasket in place) onto the rear cylinder and on to the front headpipe. Make sure the front headpipe is pushed in as far as possible into the rear headpipe collector assembly inlet. Use the stock nuts to fasten the headpipe to the cylinder. Snug the nuts but **DO NOT TIGHTEN** at this time. See **FIGURE 5**.
11. Install the left rear crossover pipe onto the rear headpipe collector assembly making sure it slides into the outlet of the rear headpipe collector assembly outlet as far as possible. See **FIGURE 5**.

Continued on Page 3

**NOTE:** Arrows point to the position of the hex head of the clamps.

REAR CROSSOVER PIPE

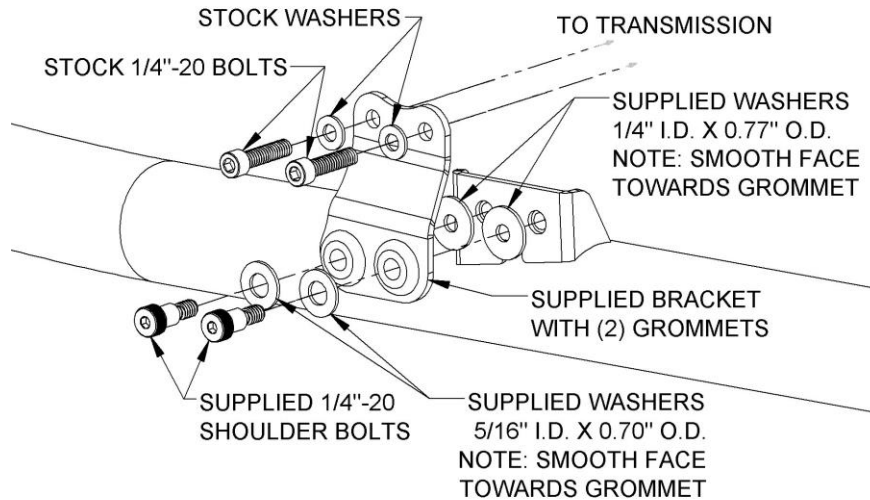


27-61 MSC CLAMP

**FIGURE 5**

FRONT HEADPIPE SUPPORT

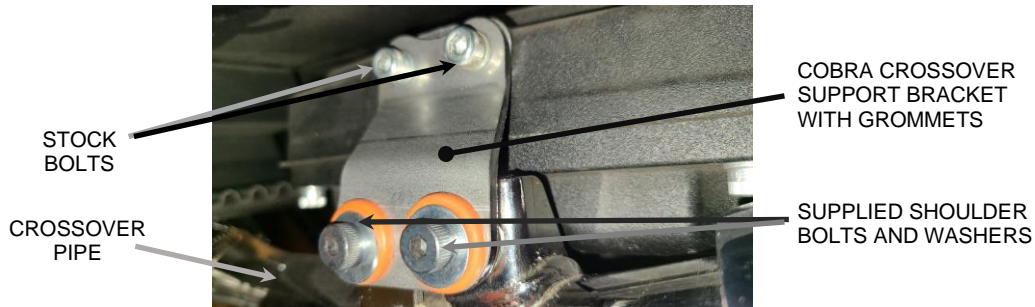
12. Using **FIGURE 6** below, insert the 5/16" I.D. washer over both supplied shoulder bolts, make sure the smooth side of the washer is facing toward the threads of the bolts. Insert them through the grommets on the supplied bracket, be sure the bracket is oriented as shown in **FIGURE 6**. On the other side of the bracket, install the 1/4" I.D. washer over the shoulder bolt threads. Ensure that the smooth side of each washer is contacting the grommet. (The stamped side with sharp edge must face away from the grommet to ensure long life of the grommet.) Apply blue Loctite to the threads of the shoulder bolts. Thread both shoulder bolts and bracket assembly loosely onto the welded mount on the crossover assembly. See **FIGURE 6**.



**FIGURE 6**

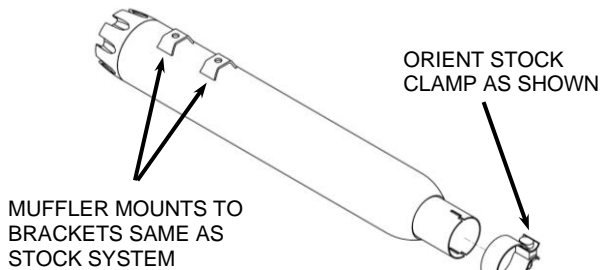
13. Apply blue Loctite on the (2) stock allen bolts, install them along with (2) stock washers into the mount bracket upper holes and transmission, lightly snug the bolts but **DO NOT TIGHTEN** at this time, see **Figure 7**. Adjust the crossover pipe fore and aft so the mount with grommets rest flush against the rear of the transmission case. **IMPORTANT: DO NOT** force the crossover pipe forward or backward or up and down to get it into position. If a lot of force is needed to align the crossover pipe and support bracket then adjust the rear headpipe collector assembly until it will align with only enough force to counter act the weight of the left side of the crossover assembly. Also, make sure the crossover pipe has clearance all around and does not make contact with the transmission pan. Adjust as needed while bolts are loose.

Continued on Page 4

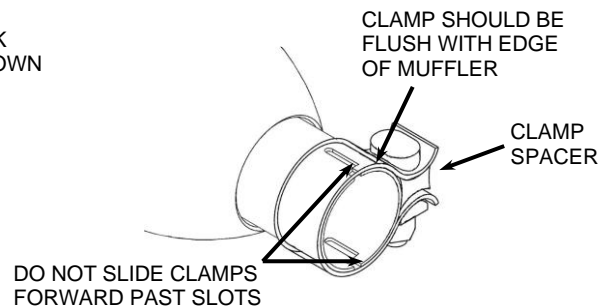


**FIGURE 7**

14. Slide the stock clamps over the slip-on mufflers and position them as shown in **Figure 8 & 9** with the hex head facing inward and towards the ground.
15. Slide the mufflers onto the headpipes until the mounting holes align. Reinsert the (2) stock 5/16-inch bolts into each rear muffler mount. Note: Indent on right muffler will face inward. **Do not tighten** clamps or bolts.
16. From the rear, rotate the mufflers as needed so they are level with the ground and parallel with each other.



**FIGURE 8**

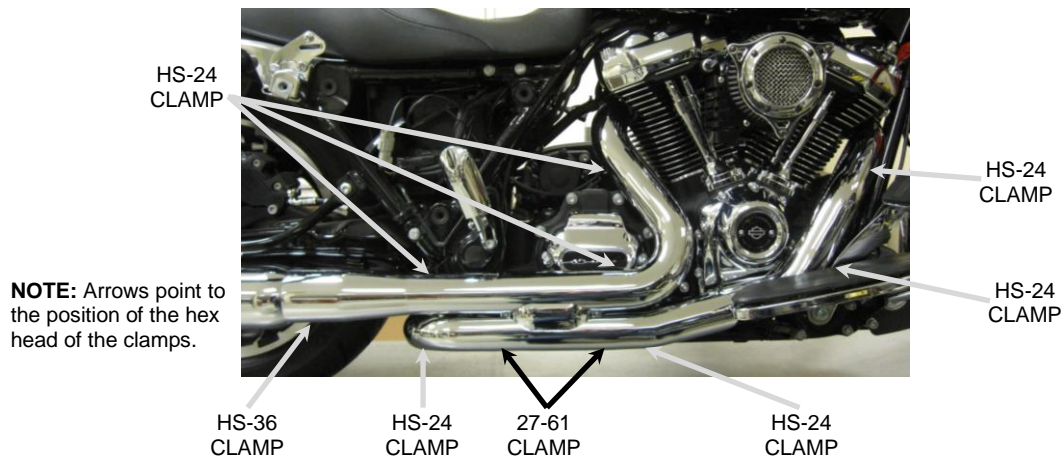


**FIGURE 9**

17. Make sure the front headpipe, rear headpipe collector assembly, left rear crossover pipe, and mufflers are aligned properly and tighten the (2) crossover support bracket shoulder bolts, then proceed to tighten the (2) previously installed stock allen bolts in the transmission case to factory specification. See **FIGURE 7**
18. Fully tighten the flange nuts on the exhaust port studs, followed by the nut for the 3/8" carriage bolt on the front headpipe support clamp and the nut on the front headpipe support bracket. See **FIGURES 1, 2 & 3**.
19. Next fully tighten the (2) 27-61 MSC clamps on the rear headpipe collector assembly. (NOTE: The clamps should be flush with the end of the crossover assembly inlets when tightened. See **FIGURES 4 & 5**. If the clamps are slid past the slots on the crossover assembly inlet the clamps will not tighten properly).
20. Plug the O<sub>2</sub> sensors back into the motorcycle wire harness and route the wires away from the exhaust in the same manner as stock.
21. Remove the heatshields and hose clamps from packaging. Unscrew the hose clamps and feed the tail end of the clamps through the clips on the inside of the heatshield so the screws are accessible with a screwdriver once the heatshield is installed. The large HS-36 hose clamp goes on the rear clip on the rear heatshield. See **FIGURE 10 & 12** for proper positioning of the clamps on the heatshields. (NOTE: The **arrows point to the positioning of the hex head of the clamps**. The hex head of the clamps should be accessible for tightening but not visible when the heatshields are mounted to the pipes.)

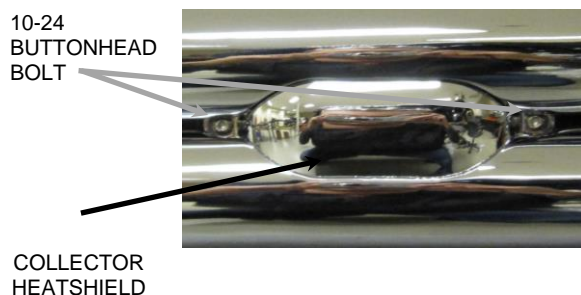
Continued on Page 5

22. Install the right rear heatshield over the rear headpipe. (Hint: Spread the hose clamps apart slightly to make it easier to slide them over the headpipes.) Align the heatshield with the headpipe and the collector heatshield. There should be an even gap around the collector heatshield. Snug the clamps but **DO NOT TIGHTEN** at this time. See **FIGURE 10 & 11**.
23. Install the right front heatshield over the right front headpipe. (Hint: Spread the hose clamps apart slightly to make it easier to slide them over the headpipes.) Align the heatshield with the headpipe and the collector heatshield. There should be an even gap around the collector heatshield. If the heatshield does not align well with the collector heatshield then the rear crossover pipe may need to be loosened and pushed forward or backward. When the heatshield is aligned properly snug the clamps but **DO NOT TIGHTEN** at this time. See **FIGURE 10 & 11**.
24. If the heatshields will not align properly with the collector heatshield then the collector heatshield may need to be loosened and moved forward or backward. Loosen the two button head bolts to adjust the collector heatshield forward or backward. See **FIGURE 11**.

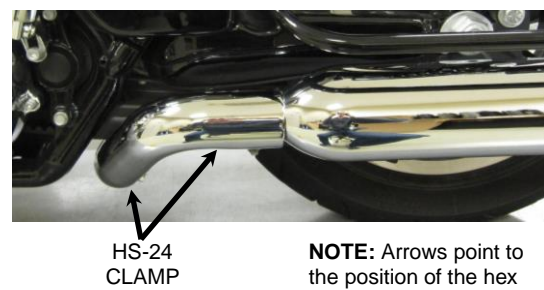


**FIGURE 10**

25. Place left rear heatshield in position on the crossover assembly on the left side of the motorcycle. (Hint: Spread the hose clamps apart slightly to make it easier to slide them over the headpipes.) Align the heatshield with the crossover assembly and snug the clamps but **DO NOT TIGHTEN** at this time. See **FIGURE 12**.



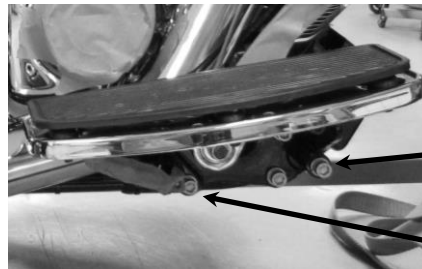
**FIGURE 11**



**FIGURE 12**

Continued on Page 6

26. Adjust the mufflers fore and aft to align the front of the mufflers with the rear of the heatshields. Make sure there is a small gap between the front of the mufflers and the heatshields. Rotate the mufflers so they are level with the ground and then tighten the muffler mounting bolts and the clamps. (NOTE: The clamps should be flush with the end of the muffler inlet when tightened. If the clamps are slid past the slots on the muffler inlet the clamps will not tighten properly. Also, make sure the clamp spacer is not over the slots. The slots need to be covered by the clamp band so that it seals the slots properly. Rotate the clamp if necessary). See **FIGURE 9**.
27. Make sure the heatshields are aligned properly with the collector heatshield and that the small gap is maintained from **Step 23** and as shown in **FIGURE 11**. then tighten all hose clamps securing the heatshields.
28. Insert the supplied floorboard spacer plate between the rear floorboard mount and the frame, then align the dowel pin and reinstall the socket head bolt. Tighten to factory specifications. See **FIGURE 13**.
29. Remove the socket head bolt from the right front floorboard mount. Place the supplied thick washer between the front floorboard mount and the frame. Reinstall and tighten the socket head bolt to factory specifications. See **FIGURE 13**.



INSTALL THICK 3/8"  
FLAT WASHER ON  
FRONT MOUNT

INSTALL SPACER  
PLATE ON REAR  
MOUNT

**FIGURE 13**

30. Reinstall any other previously removed items. Tighten to factory specifications.
31. Make sure all the hardware (brackets, headpipes, heatshields, mufflers and floorboards) have been tightened appropriately.
32. **IMPORTANT: On BLACK exhaust, before starting your engine remove all fingerprints from all exhaust surfaces. To clean your black exhaust system, use a liquid based soap detergent, such as dishwashing soap applied with a soft cloth and rinse with clean water. Note: Avoid abrasive cleaning methods such as granular or dry cleansers, simple green, scotch-brite or steel wool pads. Abrasives may breach the coating and shorten life.**

**IMPORTANT: It is recommended that you re-tune the fuel settings on your motorcycle for optimal performance.**

DISCLAIMER: NOT LEGAL FOR SALE OR USE IN CALIFORNIA ON ANY POLLUTION CONTROLLED MOTOR VEHICLE. THE SALE, USE, OR INSTALLATION OF THIS PRODUCT MAY ALSO BE ILLEGAL NATIONWIDE UNDER THE FEDERAL CLEAN AIR ACT (42 U.S.C. § 7522(A)(3)).