

Items Supplied >

- 1 - INTAKE COVER W/ SCREEN / RING ASSEMBLY
- 1 - K&N® VENTURI AIR FILTER
- 1 - BILLET VELOCITY STACK
- 1 - MOUNTING PLATE
- 1 - SUPPORT BRACKET
- 1 - BOLT, M5 X 12mm, ALLEN
- 2 - BOLT, M6 X 16mm, ALLEN
- 3 - BOLT, M6 X 25mm, ALLEN
- 2 - BOLT, M6 X 12mm BUTTONHEAD
- 4 - BOLT, 1/4"-20 X 1/2", BUTTONHEAD
- 3 - WASHER, INTERNAL TOOTH LOCK
- 1 - O-RING, 2.88 "I.D. X .125", BUNA-N
- 1 - BILLET BREATHER FILTER

Application(s) >

KAWASAKI VN900

2006 - 2017

Instruction Manual >

06-0467 - 01B / 02B / 03B / 04B

Page 1 of 2

Read all instructions carefully and completely before installing your new POWRFLO™ Intake.

1. Remove the (4) bolts that hold on the stock air cleaner cover. Once the cover has been removed, loosen the top bolt to remove the filter from air box.
2. Remove the air box by loosening the (5) allen bolts around the air inlet and the (2) hex bolts from the lower portion of the air box. See Figure 1. Disconnect the (2) hoses, idle adjuster and air temperature sensor connector from the air box.
3. Once the air box has been removed, unscrew the air temperature sensor and install it into the supplied mounting plate using the supplied M5 bolt, refer to Figure 3. **NOTE:** Make sure the small stock o-ring around the sensor is still intact.
4. Install the supplied billet breather filter into the upper hose (disconnected in Step 2) and clamp. Rotate the hose so the billet breather filter is pointed to the rear and resting slightly on top of the throttle body.
5. Insert the supplied o-ring into the groove of the supplied velocity stack. **NOTE:** Do not attempt to stretch the o-ring into groove; position o-ring evenly around groove and use gentle force (No tools) to push it in.
6. Bolt the velocity stack to the throttle body using the (2) supplied M6 x 16mm allen bolts and tighten. See Figure 2.

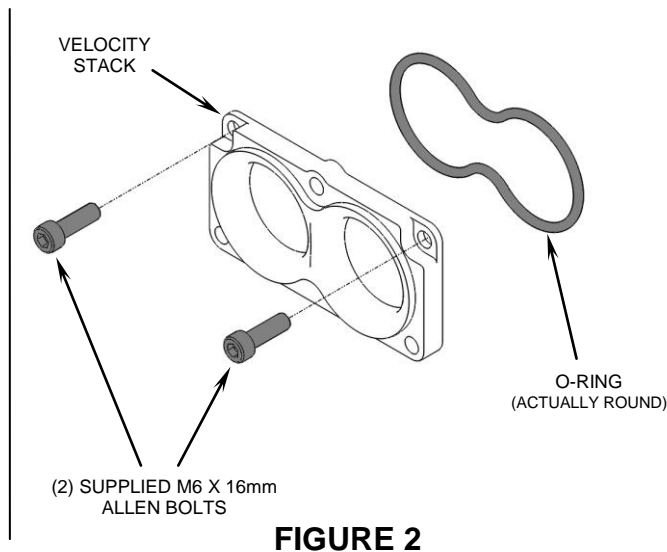
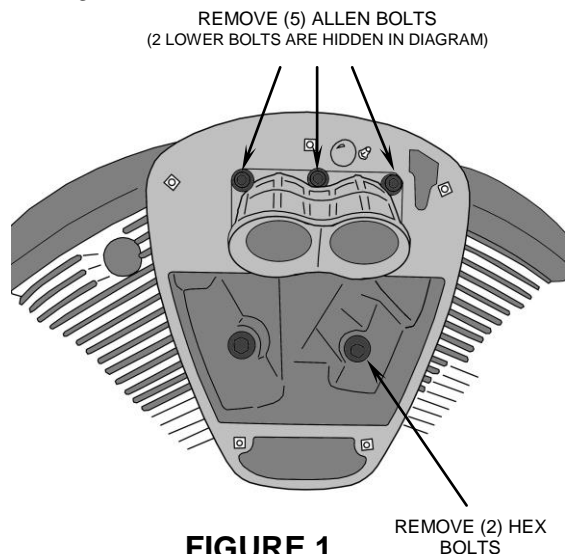

* Cobra® recommends you always wear a helmet while riding. Please never operate your motorcycle while under the influence of alcohol and/or drugs. Enjoy the new look of your motorcycle and please ride safely.

- Position the mounting plate over the velocity stack (with the welded tube toward inside) and secure using (3) supplied M6 x 25mm buttonhead bolts and (3) internal tooth lock washers, finger tighten only, Figure 3.
- Install the supplied support bracket to the two threaded bosses near the base of the cylinders using the (2) supplied M6 x 12mm buttonhead bolts. Secure the support bracket to the mounting plate using (1) supplied 1/4"-20 buttonhead bolt, and finger tighten. See Figure 4.
- Fully tighten the (3) M6 x 25mm allen bolts, from Step 7, followed by the support bracket bolts, from Step 8.
- Attach the lower hose and hose clamp that was disconnected in Step 2 to the tube on the mounting plate. Install idle adjuster onto the support bracket retaining tab. Reconnect the air temperature sensor connector.
- Insert the round intake screen into the black ring so the screen sits inside the edge of the ring. Place the ring and screen between the legs of the naked black intake cover as shown in Figure 5.
- Place the naked intake cover, ring and screen assembled in Step 11, over the air filter and align each leg to the base mounting plate threaded holes. Be sure screen sits at a 45 ° angle to the bottom leg, and C/V logo'd leg is at the upper left position. Insert the (3) supplied 1/4"-20 x 1/2" buttonhead bolts through the intake cover and into the base mounting plate, see Figure 5. Double check all parts are aligned properly and tightened securely.

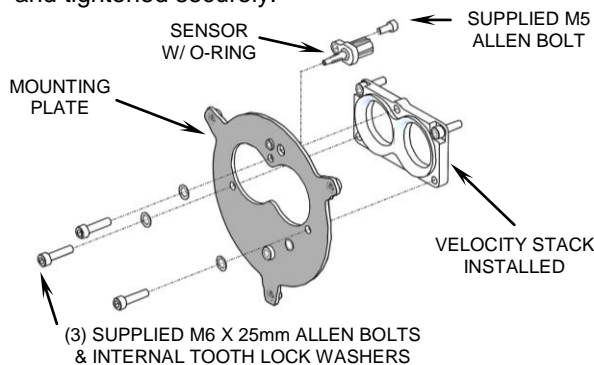

FIGURE 3

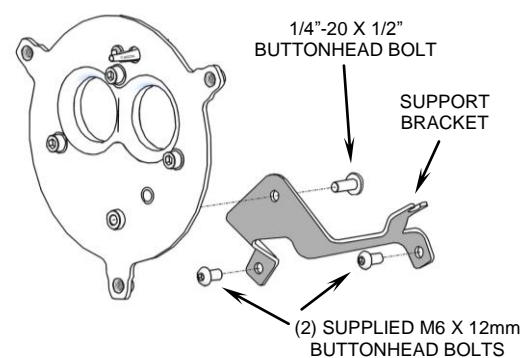

FIGURE 4

CLEANING INSTRUCTIONS:

To clean your black air intake system use a liquid based soap detergent, such as dishwashing soap applied with a soft cloth and rinse with clean water. Note: Avoid abrasive cleaning methods such as granular or dry cleansers, simple green, Scotch-Brite or steel wool pads. Abrasives may breach the coating and shorten life.

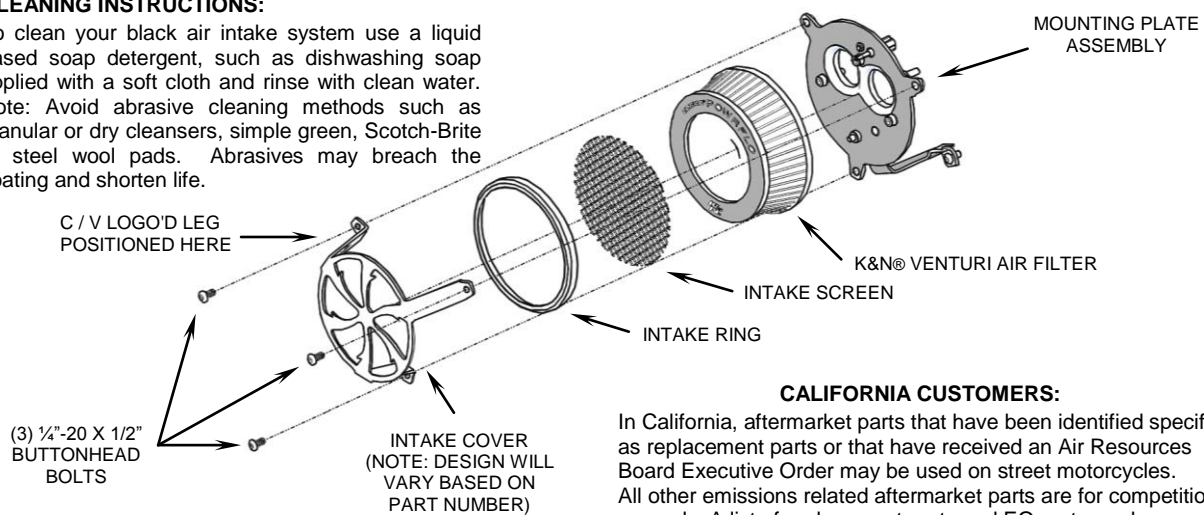

FIGURE 5

CALIFORNIA CUSTOMERS:

In California, aftermarket parts that have been identified specifically as replacement parts or that have received an Air Resources Board Executive Order may be used on street motorcycles. All other emissions related aftermarket parts are for competition use only. A list of replacement parts and EO parts, and corresponding fitment is provided at: www.cobrausa.com