

Items Supplied >

- 1 – CHROMED FREEWAY BAR
- 2 – CLAMP, BILLET ALUMINUM
- 2 – BOLT, 8 mm X 16 mm, W / LOCK PATCH
- 2 – SPACER, BLACK POWDERCOATED
- 2 – WASHER, FLAT 6MM STAINLESS

Application(s) >

YAMAHA ROADLINER	2006-2014
YAMAHA STRATOLINER	2006-2014
YAMAHA RAIDER	2008-2015

Instruction Manual >

01-2265

Page 1 of 1

Read all instructions carefully before installing your new Cobra® product!

1. Remove the front M10 bolt from the left and right floorboard mounts at frame and set aside. Loosen, but do not remove the rear M10 bolts from floorboard mounts.
2. Place the new Cobra freeway bar between front of frame and back of front fender with lower mounting brackets facing towards the rear. Slide mounting brackets between floorboard mounts and frame and align holes. (See Figure 1.) Start M10 bolts removed from Step 1 and leave loose. Rotate top of freeway bar towards frame and install supplied billet clamps and M8 bolts and snug. (See Figure 2.) Raider only, place 6mm flat washers between frame and brake line clamps. (See Figure 3)
3. Remove the (2) rear M10 bolts from the left and right floorboard mounts loosened in Step 1, place the supplied spacers between frame and mount and re-insert M10 bolts and snug tight.
4. Tighten all bolts starting with (2) M8 billet clamp bolts making sure clamps do not rotate and stay seated against frame tube. (See Figure 2.) Next tighten the (4) M10 floorboard mounting bolts. Torque all bolts to there appropriate values.

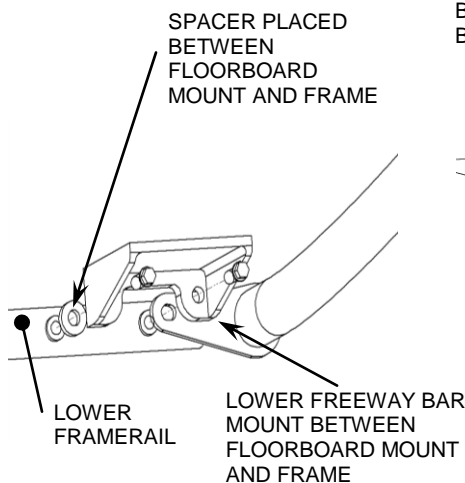

FIGURE 1

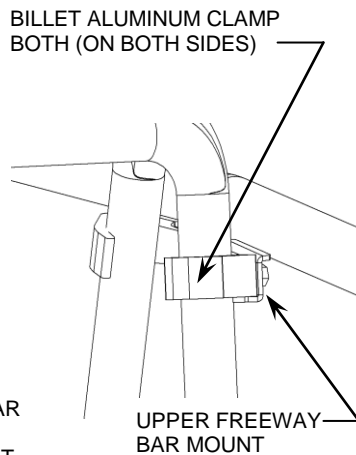
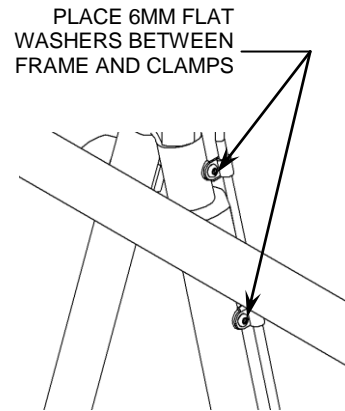

FIGURE 2



RAIDER ONLY

FIGURE 3

Cobra Freeway Bars add style to your motorcycle. They are not designed to withstand a serious impact and may not protect you and/or your motorcycle in the event of a crash.

*** Cobra® recommends you always wear a helmet while riding. Please never operate your motorcycle while under the influence of alcohol and/or drugs. Enjoy the new look of your motorcycle and please ride safely.**